



Technical Specification

	24EE3K 24EE3KR 24EE3KW 24EE4K 24EE6K 24EE7K
Energy Efficiency Class (SDR)	E
Power consumption (SDR)	17 W
Screen resolution (pixels)	1366 x 768
Screen Size (diagonal)	60 cm / 24 inches
RF	75 ohm Antenna / Analog / DVB / Satellite
Inputs	3 x HDMI • 2 x USB • 1 x Micro SD card slot 1 x RJ45 LAN/Ethernet • 1 x Composite/CVBS Video 1 x L/R Audio input for Composite/CVBS
Sound Outputs	1 x Digital Optical Audio output, 1 x 3.5mm Headphone
Speaker*/ Amplifier Watts (RMS)	2 x 5 / 2 x 3
Voltage and power consumption	AC 220V ~ 240V; 50Hz 17/40W (home mode/max) (<0.5W in Standby)
Dimensions including stand (mm)	560W x 385H x 140D
Net weight (Kgs)	3.8
Wall Mounting	VESA 100 x 100 (mm)



The terms HDMI, HDMI High-Definition Multimedia Interface, HDMI trade dress and the HDMI Logos are trademarks or registered trademarks of HDMI Licensing Administrator, Inc.



Manufactured under license from Dolby Laboratories. Dolby, Dolby Audio, and the double-D symbol are trademarks of Dolby Laboratories Licensing Corporation.



For DTS patents, see <http://patents.dts.com>. Manufactured under license from DTS, Inc. (for companies headquartered in the U.S./Japan/Taiwan) or under license from DTS Licensing Limited (for all other companies). DTS, DTS-HD Master Audio, DTS-HD, VirtualX, and the DTS-HD logo are registered trademarks or trademarks of DTS, Inc. in the United States and other countries. © 2021 DTS, Inc. ALL RIGHTS RESERVED.

Quick Start Set Up Guide

For information on using the TV's features, please refer to the Operating Instructions which can be found online.

Model Numbers

- 24EE3K
- 24EE3KR
- 24EE3KW
- 24EE4K
- 24EE6K
- 24EE7K

Register your manufacturers guarantee online within 14 days of purchase at www.registertoday.co.uk/sharp and enter into a prize draw to...



Quick & easy guide for setting up your TV

- What is included in the box
- Using the remote control
- Setting up the TV for the first time - including attaching the stand
- Connecting other devices to the Television

Need help setting up or using your TV?

Please contact the UK & ROI Helpline*
Telephone UK 0330 024 0803 or ROI 01443 3323
Online support at: www.umc-uk.co.uk
Email support at: service@umc-uk.co.uk

*Calls to 0330 numbers are charged at standard call rates and are included as part of any bundled minutes with your phone provider. Hours are correct at time of this document being published.
Please note these hours are subject to change periodically.
Calls to the ROI number are charged at the local call rate.

The telephone opening hours are:

- Monday to Friday: 8.30am – 6pm
- Saturday: 9am – 5pm
- Bank Holidays: 10am – 4pm

Closed Christmas and New Year day.



Please save your box/packaging as you will need this in the event of warranty/service repair or support. We are unable to carry out warranty/service if you are unable to package it correctly. The safest way to package your item in the event of warranty/service repair is in its original box/packaging.

Freeview Play brings together live TV viewing with "catch up" TV services such as BBC iPlayer, ITV player, More4 and Demand 5. The Freeview Play Explore app features a carousel of genres to select from when searching for programmes, such as sport, comedy, dramas and soaps, etc. Content is made up from recommendations of the major broadcasters and offers an alternative means of searching.

Note that to use the full functionality of Freeview Play your set must be connected to the internet.

This product contains technology subject to certain intellectual property rights of Microsoft. Use or distribution of this technology outside of this product is prohibited without the appropriate license(s) from Microsoft. Content owners use Microsoft PlayReady™ content access technology to protect their intellectual property, including copyrighted content. This device uses PlayReady technology to access PlayReady-protected content and/or WMDRM-protected content. If the device fails to properly enforce restrictions on content usage, content owners may require Microsoft to revoke the device's ability to consume PlayReady-protected content. Revocation should not affect unprotected content or content protected by other content access technologies. Content owners may require you to upgrade PlayReady to access their content. If you decline an upgrade, you will not be able to access content that requires the upgrade.



RF Cable

If you don't have the RF cable shown below, then you can purchase one from www.umc-uk.co.uk/cables. If you are intending to connect your TV to an RF socket in order to receive Freeview you will need this cable.

Additional Accessories

- 1 x Quick Start Guide
- 1 x Remote Control and 2 x AAA Batteries
- 1 x Safety Leaflet
- 1 x Stand installation pack

Included with this TV are the following accessories

What is included in the box

To launch the Online Manual, press the [MENU] button and then select Settings > Setup > Help Information

Online Manual

Sky Remote Code

If you wish to use your Sky remote to operate the TV's basic functions, you will need a Sky remote control (Revision 9 or later) and you will need to program it with the code 2134. If you wish to use your Sky Q remote to operate the TV's basic functions, you will need to program it with the code 4170.

- 1 STANDBY** - Switch on the TV when in standby or vice versa.
- 2 SOURCE** - To display the input/source menu.
- 3 NUMBER BUTTONS** - 0-9 to select a TV channel directly.
- 4 MUTE** - Mute the sound or vice versa
- GUIDE** - Opens the 7 day TV guide (digital TV mode).
- MENU** - Displays the OSD menu.
- FAV** - Displays the favourites menu.
- INFO** - Press once for now/next channel information.
- INFO** - Press twice for information about the current programme.
- ▲/▼/▶/◀/OK** - Allows you navigate the on-screen menus and adjust the system settings to your preference.
- BACK** - To go back a previous step.
- APPS** - Access the Apps menu.
- EXIT** - To exit all menus.
- VOL (+/-)** - Tilt to increase/decrease the sound level.
- CH (+/-)** - Tilt to move up or down the channel being watched.
- NETFLIX** - Access the Netflix App.
- PRIME VIDEO** - Access the Prime Video App.
- YOUTUBE** - Access the YouTube App.
- FREEVIEW PLAY** - Access the Freeview Play App.
- AUDIO** - Scrolls through the sound mode options
- SUB** - To switch the dialogue at the bottom of the screen (on/off).
- TEXT** - To enter/exit Teletext.
- TV** - To switch to digital Channels
- MI** - To play/pause
- ▶▶** - To play in fast forward mode
- ◀◀** - To play in fast rewind mode
- ◻** - To stop the playback
- COLOUR BUTTONS** - Execute corresponding function at that time

REMOTE CONTROL

Setting up the TV set for the first time

1 Fitting the stand

For stand installation, there are two types of screws provided as shown below. To complete the stand installation you will require a cross head screw driver.

Place the TV set on a flat and clean surface with the panel facing downwards to avoid damage.

3 x M (4x12)

4 x ST (4x12)
Used for attaching the stand base to the stand neck (fig.3)

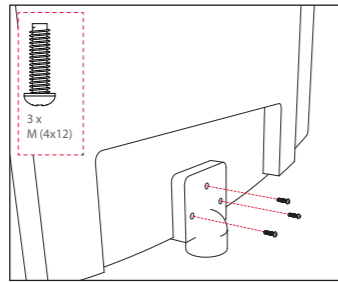

1 Attach the stand neck to the rear of the TV set using the 3 x M(4x12) screws

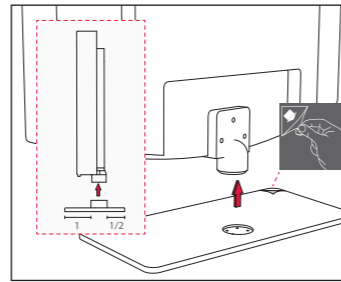

2 Peel off the protective plastic cover then attach the stand base to the neck.

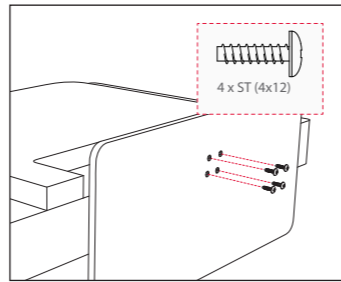

3 Secure the base to the neck by using the 4 x ST(4x12) screws provided.

HELPFUL ADVICE FOR FIRST TIME STAND INSTALLATION

When securing the self-tapping screw/s into the base of the stand (on first installation) the screw/s will be naturally tight as they create a thread in the plastic of the stand neck in order to support a TV of this size.

A. Ensure the cross head screw driver tip fits correctly into the head of the screw and that it is not too big or small.

B. Screw in all screws individually and partially before tightening all of the screws fully.

C. If they become very tight try loosening them slightly and then re-tightening them once again as this will continue the process of creating the thread for the screws.

Win a SHARP Soundbar

Register your manufacturers guarantee online within 14 days of purchase at www.registertoday.co.uk/sharp and enter into a prize draw to win a Sharp Soundbar

Terms and conditions apply. Online registration only.



2 Connecting your set

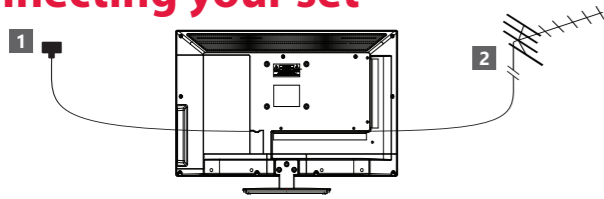

1 Connect the TV to your power socket.

2 If you wish to use the TV to receive Freeview/Saorview channels, connect the RF input from the TV to your outdoor Digital TV aerial. If you do not wish to receive Freeview/Saorview, skip this step.

3 Button layout



- 1** Stop/Eject Disc For DVD models only
- 2** Play/Pause Disc For DVD models only
- 3** Volume up and menu right
- 4** Volume down and menu left
- 5** Programme/Channel up and menu up
- 6** Programme/Channel down and menu down
- 7** Displays Menu/OSD
- 8** Displays the input source menu
- 9** Standby Power On/Off

Remote Control: Installing Batteries

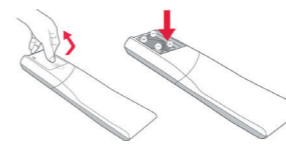

Insert the batteries supplied into the remote control and press the standby button to power on the TV.

Wall Mounting the TV

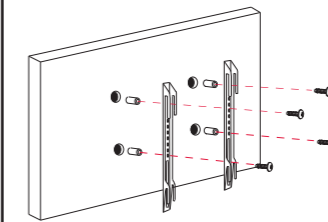

Image for illustration only.

For the dimensions of the VESA mounting, please refer to the Technical Specifications section of this document.

1 Remove the four screws that are supplied in the wall mounting holes.

2 The wall mount can now be easily attached to the mounting holes on the rear of the TV.

3 Install the wall mounting bracket to the television as advised by the bracket manufacturer.

The picture shows the use of spacers, which are not applicable to all sets/installations.

4 First time installation

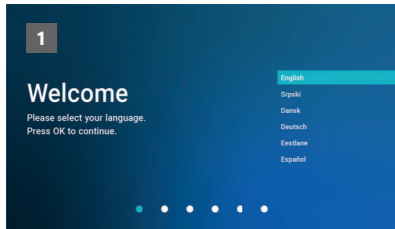

Introduction & Language

When the set first turns on, it enters the First Time Installation mode. This can be restarted by restoring the set to default settings in the 'About TV' Menu. Select your preferred on-screen display language. This will change the language in which the menus and associated information is displayed in.

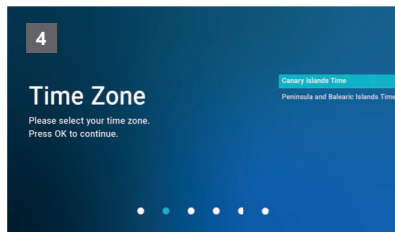

Time Zone

Set the Time Zone in which the TV will reside. This may be dependent on the country you select in step 2.

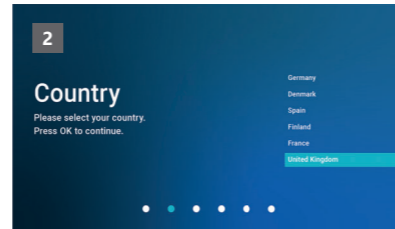

Country

Select the correct country in which the set will be used in. This will enable the set to correctly install the functions applicable in the country of use.



Updates Notice

You will need to agree to certain information collection for the TV set to operate as intended.

Note: In home mode, the TV will switch off automatically after 4 hours in the event that no buttons are pressed on the TV or remote control.

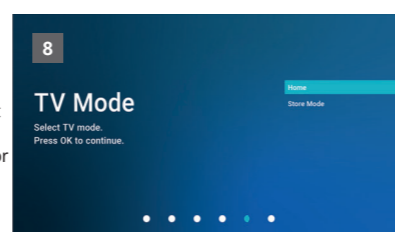

TV Mode

Home Mode: For normal use, by default it is set to a power saving mode which reduces the energy used by up to 25% (by reducing the power to the LED/LCD panel). This can be changed in the picture mode settings.

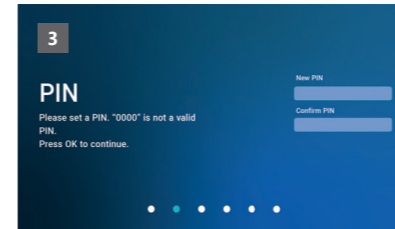

PIN

This needs to be set to establish parental controls.

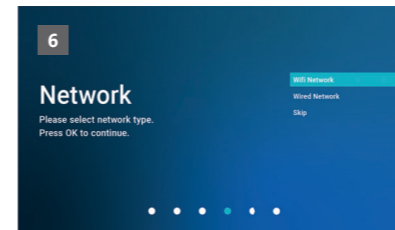

Network Set Up

You can connect the TV to your broadband router or wireless network in order to take advantage of the Smart functions. If you connect the TV to your router using an Ethernet cable, the Wifi set up will be skipped.

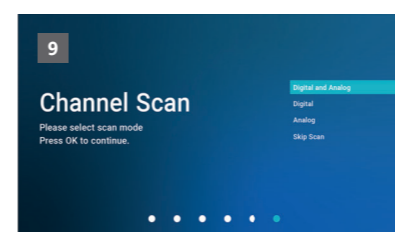

Channel Scan

Choose to install terrestrial channels via Digital or Analog signals.
Note: Analog signals in the United Kingdom have been turned off. Only Digital signals are available.

Connectivity

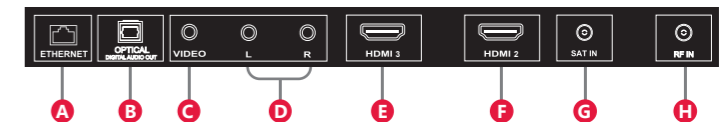
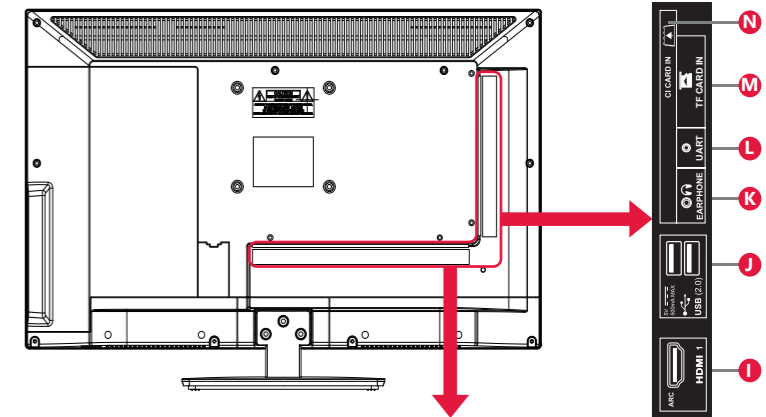

A LAN*	Network Connection	H RF In	RF / TV Aerial input
B Digital audio	Digital optical audio output	I HDMI 1 (ARC)	HDMI input with ARC
C Video	Video input	J USB 2.0	USB 2.0 input x2
D L/R	Audio Shared for video	K Earphones	Earphones Input
E HDMI 3	HDMI input	L Service Input	Input used by Service Centers
F HDMI 2	HDMI input	M TF Card In	Micro SD Card input
G Sat In	Satellite Input	N CI card in	Common interface module